

Continental[®]

Refrigerator

OPERATIONS MANUAL



easy Electronic Control

FOR REFRIGERATORS, FREEZERS AND WARMERS

IMPORTANT NOTE: Any unauthorized changes to Tech Service Parameters may damage equipment and void warranty.

SCAN this code
to download manual



1-800-523-7138

Continental Refrigerator
*A Division of National Refrigeration
& Air Conditioning Products, Inc.*
539 Dunksferry Road
Bensalem, PA 19020-5908
P 215-244-1400
F 215-244-9579
www.continentalrefrigerator.com

	Page
Electronic Control Display and Button Description	4
Initial Sequence of Operation	4
Electronic Control User Level Parameters	5
How to Change the Set-Point	6
How to Initiate a Manual Defrost	7
How to Change the Defrost Interval	8
How to Turn the AUX (Anti-Condensate) Heaters ON/OFF	9
How to Calibrate the Temperature Display	10
How to Change the High and Low Temperature Alarm Set Points	11
How to Silence the Alarm Beeper	12
How to Switch the Controller OFF/ON	13
How to Lock/Unlock the Controller Keypad	14
How to Access the Tech Service Parameters	15
How to See the Evaporator Probe Temperature	16
How to Activate EZY Set Parameters/Restore Factory Settings	17
Control Troubleshooting	18
Electronic Control Error Codes	20
Probe Resistance Values	20
How to Remove the Electronic Control	21
Split Control Parameters	22
Self-Contained Control Parameters	24
Warmer Control Parameters	26

ELECTRONIC CONTROL DISPLAY AND BUTTON DESCRIPTION

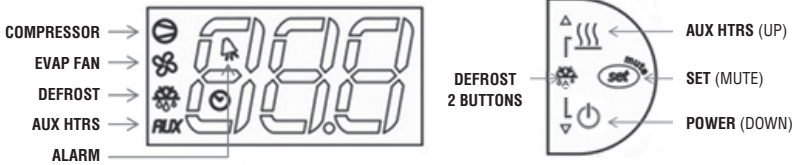



The control icons shown above will be illuminated when the associated function is active. If the icons are flashing, it means the function will be activated after the controller delays are finished.

The easy control has a “3” button interface.

- The “**AUX HTRS/UP**” button is used for activation or deactivation of the auxiliary anti-condensate heaters or for increasing values.
- The “**SET/MUTE**” button is used to lock in a new value or to silence the alarm beeper.
- The “**POWER/DOWN**” button is used to turn the unit on/off or for decreasing values.
- Press the **UP** and **DOWN** buttons simultaneously to put into a manual defrost.

INITIAL SEQUENCE OF OPERATION

1. Cabinet is plugged in.

 - a. Display will show “F” and the firmware version, then will show “P” and the parameter version.
 - b. Display will then show current cabinet temperature.
 - c. The compressor icon and the auxiliary heater icon may flash for a period of time, indicating normal delayed start-up.
 - d. After the start-up delay, the compressor and evaporator fan(s) will start if the control is calling for cooling. The fans may pulse on and off when the compressor is off to conserve energy.
2. The control will cycle the compressor on and off determined by the Set-Point and Differential Temperatures. (If the Set-Point needs to be changed, please see instructions on **Page 6**).

 - a. The Set-Point is the preprogrammed temperature which shuts off the compressor.
 - b. The Differential is the preprogrammed temperature that is added to the Set-Point temperature that will start the compressor.

EXAMPLE: Set-Point is 36°F and the Differential is 4°F
The compressor and condenser fan(s) will cycle off at 36°F and back on at 40°F.

3. The control may be preprogrammed to initiate a defrost by time interval. (If additional defrost cycles are needed or a manual defrost is required due to conditions, please see the instructions on **Pages 7 & 8**).

 - a. During defrost, the defrost icon will appear in the display and the compressor will turn off until a preprogrammed temperature or time is reached. During this time for freezers only, evaporator fan(s) will also turn off and the defrost heater will be energized.
 - b. After a preprogrammed evaporator temperature or time has been reached, there may be a short delay for both the compressor and evaporator fan(s) to restart.
 - c. After the defrost cycle is completed, the control will resume normal operation.

If you have any questions, please contact the Technical Service Department.
Phone: (800) 523-7138 • Email: service@continentalrefrigerator.com

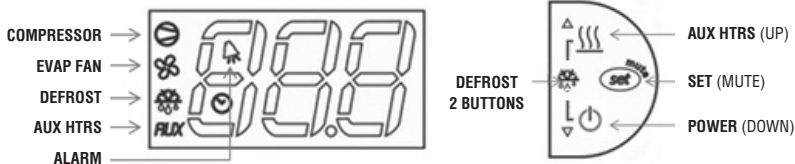

ELECTRONIC CONTROL USER LEVEL PARAMETERS

User level parameters give the end user the option to customize their control.

TO ACCESS AND CHANGE USER LEVEL PARAMETERS

- Press and **HOLD** the “SET” button until “PS” appears flashing in the display. **RELEASE** the “SET” button. You now have access to the User Parameters.
- Use the “UP” or “DOWN” button to go to the parameter.
- Press and **RELEASE** the “SET” button to access the parameter settings.
- Use the “UP” or “DOWN” button to change the parameter value.
- Press and **HOLD** the “SET” button for 5 seconds to lock in the new value.
- When the display returns back to cabinet temperature, **RELEASE** the “SET” button.

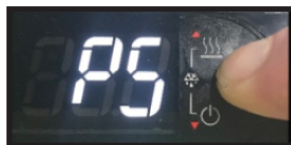

Parameter	Description	
PS	Password used to access tech service parameters	Used by service personnel to access tech service parameters
/C1	Display probe offset value	Used to calibrate the temperature display
dl	Defrost interval	Hours between defrost. The lower the value, the more defrosts per day.
AL	Low temperature alarm setting	Used to set the low temperature alarm value.
AH	High temperature alarm setting	Used to set the high temperature alarm value.
H4	Alarm beeper	0: Beeper active 1: Beeper not active

For a more detailed description on how to access and change these parameter values, there are individual pages in this manual with detailed instructions.

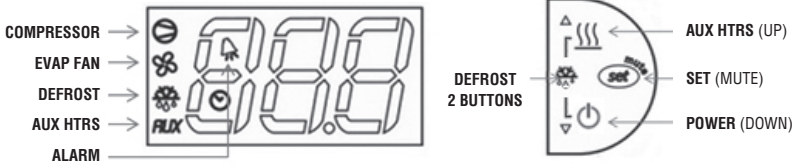

HOW TO CHANGE THE SET-POINT

The set-point is the temperature at which the compressor will shut off. **Please note** the set-point is not the cabinet holding temperature. Please refer to **Page 4** for an explanation of set-point and differential.

1. Press and **HOLD** the “SET” button until the current set-point begins flashing. **RELEASE** the “SET” button.



2. Press the “UP” or “DOWN” button to adjust to the new set-point value. Here the “UP” button was pressed to change the set-point from 36°F to 37°F.



3. Press and **RELEASE** the “SET” button to lock in the new set-point. The control will now resume normal operation with the new set-point.



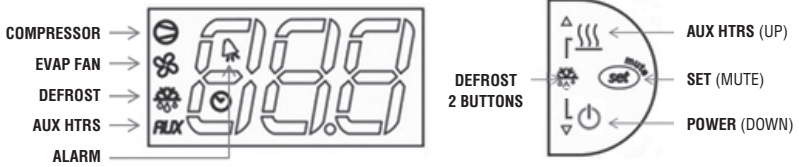

HOW TO INITIATE A MANUAL DEFROST

A one-time additional defrost may be necessary to clear accumulated ice from the evaporator coil.

1. Press and **HOLD** the “UP” and “DOWN” buttons simultaneously.
2. After 5 seconds, the defrost icon will illuminate. **RELEASE** the defrost buttons.



Defrost will terminate when the pre programmed temperature or time duration has been reached. The manual defrost can also be manually terminated by pressing and holding the “Up” and “Down” button for 5 seconds.

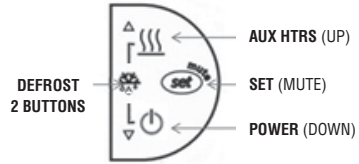
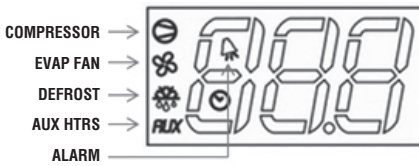

HOW TO CHANGE THE DEFROST INTERVAL

This is used to increase or decrease the frequency of defrosts. If the interval is set at “8”, a defrost will occur every 8 hours. If you need more defrosts, lower this value.

1. Press and **HOLD** the “SET” button until “PS” appears flashing in the display. **RELEASE** the “SET” button.



2. Press the “UP” button until “dl” appears (defrost interval). **RELEASE** the “UP” button.



3. Press and **RELEASE** the “SET” button. The current defrost interval will appear in the display.



4. Press the “UP” or “DOWN” button to adjust to the new defrost interval. Here the “DOWN” button was pressed to change the interval from every 8 hours to every 6 hours.



5. Press and **HOLD** the “SET” button to lock in this new value. When the display returns back to cabinet temperature, **RELEASE** the “SET” button.





HOW TO TURN THE AUX (ANTI-CONDENSATE) HEATERS ON/OFF

Anti-condensate heaters are located around the door to eliminate condensation. In order to save energy these heaters can be turned off.

1. To see the current state of the AUX (anti-condensate) heaters, press and **HOLD** the AUX HTR button for 1 second. **RELEASE** the AUX HTR button. The display will show the current state of the heater when the button is pressed. In this case the heaters are currently ON.

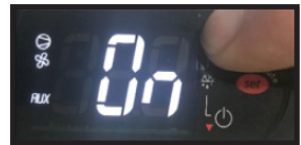

2. To change the current state of the AUX Heaters, press and **HOLD** the AUX HTR button. The display will show the current state of heater operation. After 5 seconds, the heater will switch to the opposite state and the display will return to displaying the cabinet temperature. **RELEASE** the button.

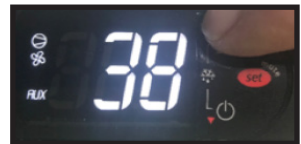
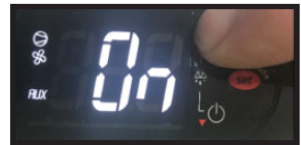

The control has a built in energy saving feature for the aux (anti-condensate heaters). When in the ON position, the "AUX" icon may not illuminate indicating the AUX heaters are not currently energized. The control will automatically energize the AUX heaters when the conditions require these heaters to be activated.

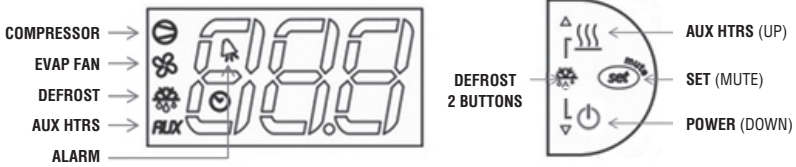

HOW TO CALIBRATE THE TEMPERATURE DISPLAY

The controller temperature display can be calibrated if required. Before attempting to calibrate the temperature display, check display by placing a pre-calibrated temperature sensing device in center of the refrigerated compartment and keep doors closed for at least 15 minutes. Temperature display should read same temperature as sensing device, within +/-2°F. If not, follow these instructions to calibrate.

1. Press and **HOLD** the “SET” button until “PS” appears flashing in the display. **RELEASE** the “SET” button.
2. Press the “UP” button until “/C1” appears in the display. **RELEASE** the “UP” button.
3. Press and **RELEASE** the “SET” button. The current value of the offset will appear in the display. In this case, the offset is set at 0.0
4. Press the “UP” button to increase or the “DOWN” button to decrease the offset value. In this case the “UP” button was pressed to increase the offset to 1.0
5. Press and **HOLD** the “SET” button for 5 seconds to confirm and save the new value. When complete, the current temperature will be displayed. **RELEASE** the “SET” button

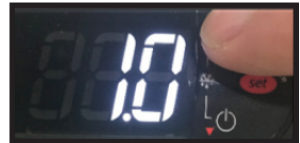

For example: If a sensing device in the cabinet reads 38° and control display shows 41°, follow steps above and decrease current offset value by 3 (if current offset value was 0, change to: -3.0 and save.)

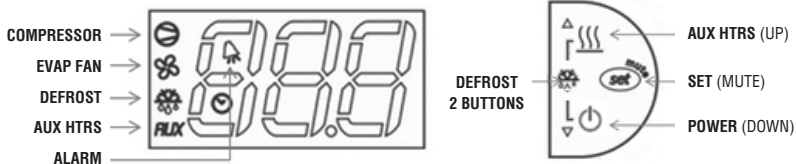

HOW TO CHANGE THE HIGH AND LOW TEMPERATURE ALARM SET POINTS

The controller has a high and low alarm set point. These values can be modified per the end user requirements. There is a pre programmed time delay for the alarm to activate to eliminate nuisance alarms.

1. Press and **HOLD** the “SET” button until “PS” appears flashing in the display. **RELEASE** the “SET” button.

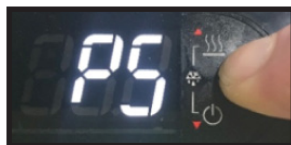

2. Press the “UP” button until “AL” (Low Alarm Setting) or “AH” (High Alarm Setting) appears in the display. **RELEASE** the “UP” button.



3. Press and **RELEASE** the “SET” button. The current alarm setting will be shown.

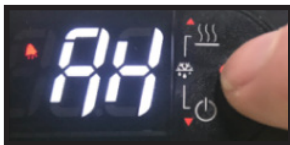

4. Press the “UP” or “DOWN” to get to the new alarm set-point. Release the button. In this case the “UP” button was pressed until the new set point of 55.0°F was reached.

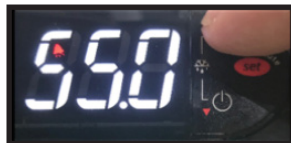

5. Press and **HOLD** the “SET” button for 5 seconds to confirm and save the new value. When complete, the current temperature will be displayed. **RELEASE** the “SET” button.



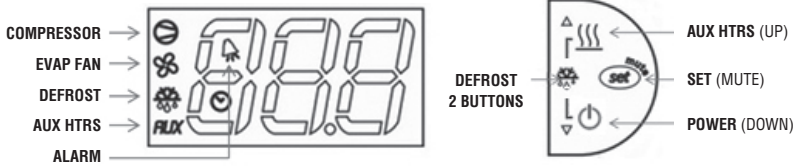

HOW TO SILENCE THE ALARM BEEPER

When a high or low temperature alarm is activated AL (low) or AH (high) will flash in the display alternating with the current cabinet temperature. At the same time, a beeper will sound. To silence the beeper for the active alarm just press and release the “SET/MUTE” button. To silence the beeper for all future alarms follow this procedure.

1. Press and **HOLD** the “SET” button until “PS” appears flashing in the display. **RELEASE** the “SET” button.



2. Press the “UP” button until “H4” appears in the display. **RELEASE** the “UP” button.

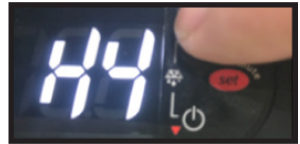

3. Press and **RELEASE** the “SET” button. “0” will appear in the display. 0: alarm beeper active.

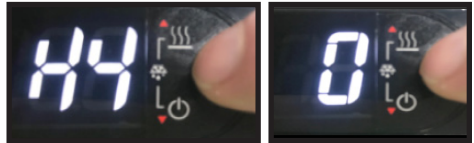

4. Press and **RELEASE** the “UP” button. 1 will appear in the display. 1: alarm beeper silenced.



5. Press and **HOLD** the “SET” button for 5 seconds to confirm and save the new value. When complete, the current temperature will be displayed. **RELEASE** the “SET” button.

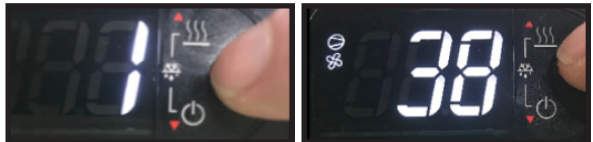

To turn the alarm beeper **ON**, follow the same instructions but change H4 from “1” back to “0”.



HOW TO SWITCH THE CONTROLLER OFF/ON

IMPORTANT: The controller can be switched OFF. This just switches OFF the controller. If servicing, the appliance must be unplugged.

1. To turn OFF controller, press and **HOLD** the “POWER/DOWN” button. When “On” appears, hold the “POWER/DOWN” button for another 5 seconds.

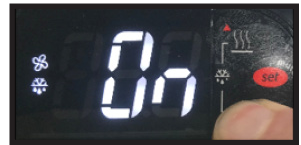

2. To turn controller back ON, press and HOLD the “POWER/DOWN” button for 5 seconds. Controller will resume normal operation.

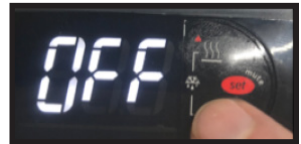

When the control is powered “OFF”, OFF will alternate in the display with the current appliance temperature.

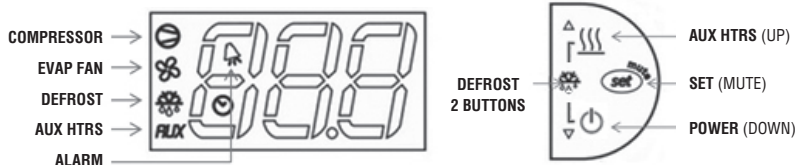

HOW TO LOCK/UNLOCK THE CONTROLLER KEYPAD

The controller keypad can be locked to eliminate any unwanted changes to the controller functions.

1. Press and **HOLD** the “SET” button until “PS” appears flashing in the display. **RELEASE** the “SET” button.



2. Press and **RELEASE** the “SET” button. “0” will be in the display.



3. Press the “UP” button until “22” appears. This is the password. **RELEASE** the “UP” button.

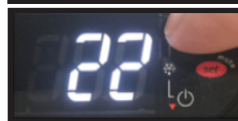

4. Press and **RELEASE** the “SET” button. “PS” will appear in the display.

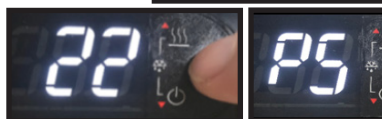

5. Press the “UP” or “DOWN” button until “H2” appears. **RELEASE** the button.



6. Press and **RELEASE** the “SET” button. “1” will appear in the display.

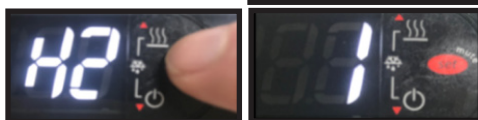

7. Press the “UP” or “DOWN” button until “0” appears. Release the “UP” or “DOWN” button.

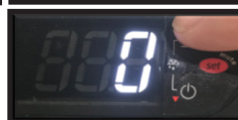

8. Press and **HOLD** the “SET” button for 5 seconds until the display returns back to cabinet temperature. The keypad will now be locked.

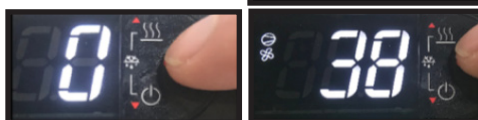

To unlock the keypad, follow the same instructions but change H2 from “0” back to “1”.



HOW TO ACCESS THE TECH SERVICE PARAMETERS

The controller has a tech service level of parameters. Please consult with Continental's service department before accessing these parameters. Adjusting these parameters in the field will affect the appliance's performance and could void the warranty.

1. Press and **HOLD** the "SET" button until "PS" appears flashing in the display. **RELEASE** the "SET" button.



2. Press and **RELEASE** the "SET" button. "0" will be in the display.

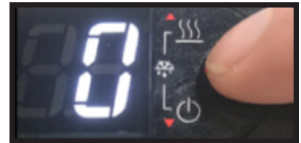

3. Press the "UP" button until "22" appears. This is the password. **RELEASE** the "UP" button.

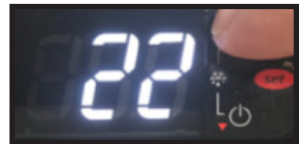

4. Press and **RELEASE** the "SET" button. "PS" will appear in the display. You now have access to the tech service level parameters. Use the "UP" or "DOWN" button to navigate to the required parameter.



5. When you get to the parameter you want to change press and **RELEASE** the "SET" button. The current setting will be shown in the display. Use the "UP" or "DOWN" button to change the value. Press and **HOLD** the "SET" button for 5 seconds to confirm and save the new value. When complete, the current temperature will be displayed. **RELEASE** the "SET" button.



HOW TO SEE THE EVAPORATOR PROBE TEMPERATURE

It may be useful for tech service personnel to see the temperature of the evaporator probe.

1. Press and **HOLD** the “SET” button until “PS” appears flashing in the display. **RELEASE** the “SET” button.



2. Press and **RELEASE** the “SET” button. “0” will be in the display.

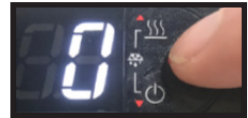

3. Press the “UP” button until “22” appears. This is the password. **RELEASE** the “UP” button.



4. Press and **RELEASE** the “SET” button. “PS” will appear in the display.

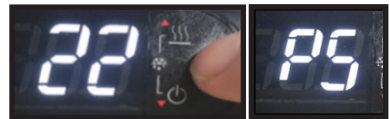

5. Press the “UP” or “DOWN” button until “d/” appears. **RELEASE** the button.

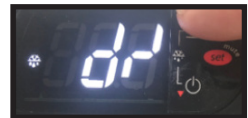

6. Press and **RELEASE** the “SET” button. The evaporator temperature will be in the display. After 30 seconds, the control will be back to displaying the cabinet air temperature.

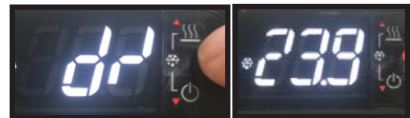

HOW TO ACTIVATE EZY SET PARAMETERS/RESTORE FACTORY SETTINGS

This is used to activate other preprogrammed parameter settings.

TABLE OF PREPROGRAMMED PARAMETER SETTINGS

	MEDIUM TEMP: COEA21K SELF CONTAINED CONTROL	LOW TEMP: C8IA41 SPLIT CONTROL
SET 1	RESTORE FACTORY SETTINGS	RESTORE FACTORY SETTINGS
SET 2	3.4°C MEDIUM TEMP FAN PULSING	-17.8°C LOW TEMP FAN PULSING
SET 3	55°F WINE REFRIG FAN PULSING	-15°F LOW TEMP FAN PULSING
SET 4	38°F FAN CONSTANT	0°F FAN CONSTANT





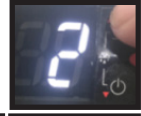
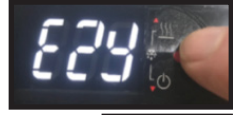
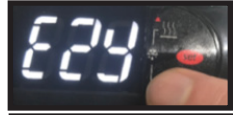

NOTE: PULSING MEANS FANS ON FOR 1 MIN. AND OFF FOR 3 MIN. THIS CYCLE CONTINUES FOR THE WHOLE OFF CYCLE.

1. Press and **HOLD** the “SET” button until “PS” appears flashing in the display. **RELEASE** the “SET” button.
2. Press and **RELEASE** the “SET” button. “0” will be in the display.
3. Press the “UP” button until “22” appears. This is the password. **RELEASE** the “UP” button.
4. Press and **RELEASE** the “SET” button. “PS” will appear in the display.
5. Press and **RELEASE** the “DOWN” button. “EZY” will appear in the display.
6. Press and **RELEASE** the “SET” button. The current EZY set will appear in the display.
7. Press the “UP” button until EZY SET required is in the display (**see table above**). Here “2” was chosen: this is the Celsius setting for the low and medium temperature controller.
8. Press and **HOLD** the “SET” button for 5 seconds. **RELEASE** the “SET” button. The control will now operate with the new parameter settings. In this case, the controller will now operate in degrees Celsius.

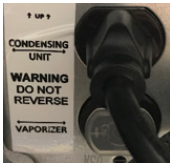

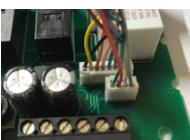
NOTE: EZY SET 1 WILL RESTORE THE ORIGINAL FACTORY SETTINGS IN ALL CONTROLLERS.

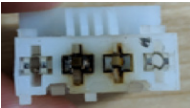
CONTROL TROUBLESHOOTING

Problem	Cause	Checks	
The compressor does not start (signalled by the compressor LED flashing)	1. Compressor safety delay in progress or defrost post dripping in progress	1. Wait for compressor safety delays or defrost dripping time to finish. Parameters: c0, c1, c2, c3, and dd. The maximum delay should not exceed 3 minutes.	
Compressor or Fan Icon Illuminated in Display and the Compressor or Fan is not Operating	1. Improper wiring 2. Faulty control	1. Check wiring and make sure getting voltage to the relay. 2. If the display icon is illuminated and getting voltage to the relay but not across the contacts, the relay is bad.	
Condensing unit running but compressor icon is not illuminated on the display.	1. Condensing unit plugged into the wrong outlet. 2. Bad compressor relay on control.	1. Check to make sure condensing unit plugged into outlet labeled for condensing unit. 2. If voltage is going across the compressor relay and the compressor icon is off, it is a bad relay.	
Blank Display Split Control	1. No power to appliance or control 2. Connection cable not fully seated at control board or display 3. Bent pins where connection cable attaches to board or display 4. Moisture damage 5. Firmware error	1. Check power at outlet. Make sure power switch on control box is ON. Check power to L & N at control board. 2. Remove display and check to make sure white connectors are fully seated and correct orientation. Check display cable at control board to make sure white connectors are fully seated and correct orientation. 3. Remove display cable at display and board and check to make sure pins are not bent. 4. Check for signs of moisture damage at or behind the control board. Remove the display and check for signs of moisture damage on the display board 5. Check to see if display is blank except for compressor icon.	   
Blank Display Self Contained Control	1. No power to appliance or control 2. Moisture damage 3. Firmware error	1. Check power at outlet. Make sure power switch on control box is ON. Check power to terminals 6 & 7 at control. Check terminal(s) that plug into control and look for burn marks or loose connections. 2. Check for signs of moisture damage on the board of the control. 3. Check to see if display is blank except for compressor icon.	 

CONTROL TROUBLESHOOTING (Continued)

Problem	Cause	Checks
Error Codes: E0 - Regulation Probe Error (Black) E1 - Evaporator Probe Error (Red) E2 - Ambient Probe Error (White)	<ol style="list-style-type: none"> 1. Loose probe wire/connections 2. Bad probe 3. Bad control 	<ol style="list-style-type: none"> 1. Make sure probes are installed in proper terminals. See parameter section of manual for wiring locations. Make sure the green terminal block on the self-contained control is fully seated. Make sure there are not any loose strands of wire. Make sure screw terminals are not clamping down on wire sheathing instead of the probe wire. 2. Ohm out probe. See Probe Resistance Value Chart. For self contained control can remove the green terminal block of probe wires from control and then take resistance values on the screw terminals. For split control, must remove probe to take resistance. 3. Remove probes from the control. With control powered, should get 5VDC between probe common and other terminal probe screws into.
Error Codes: L0 - Low Temperature HI - High Temperature	<ol style="list-style-type: none"> 1. Cabinet temperature exceeds alarm set point for 60 minutes. 	<ol style="list-style-type: none"> 1. Check alarm parameters: AL, AH, Ad.
Display High Temperature	<ol style="list-style-type: none"> 1. Something wrong with refrigeration system. 2. Door was just opened for a long duration, excessive door openings, loading warm product, missing pans in rail. 3. Set point too high 	<ol style="list-style-type: none"> 1. Do standard refrigeration system checks. 2. Keep door closed and see if temperature pulls down. NOTE: Display reads cabinet air, not product temperature. 3. Check set point and adjust if necessary. Can also increase the display delay parameters to slow down display response. Increase the /3 parameter on the split by 1. Increase the /2 parameter on the self contained by 5.
Evaporator Coil Icing	<ol style="list-style-type: none"> 1. Something wrong with refrigeration system. 2. Insufficient defrost time 3. Parameters incorrect 	<ol style="list-style-type: none"> 1. Do standard refrigeration system checks. 2. Check the DI and Dt parameters. Adjust if necessary. 3. Check parameters to parameter list in this manual.
After modifying a parameter, controller continues working with old values	<ol style="list-style-type: none"> 1. The control has not updated the old value or the parameter setting procedure has not been ended correctly by pressing the SET button for 3 s 	<ol style="list-style-type: none"> 1. Temporarily disconnect and reconnect power to the control. Go back in to parameter to see if the change worked.

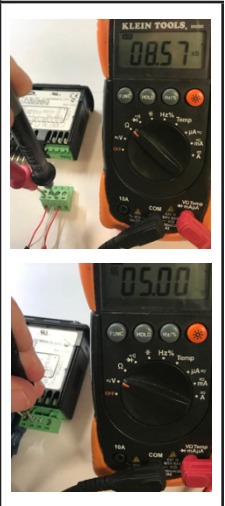

ELECTRONIC CONTROL ERROR CODES

Alarm Code	Alarm Description	Notes
E0	Regulation Probe Error	Located in return air stream (black)
E1	Evaporator Prope Error	Located in evaporator coil (red)
E2	Ambient Probe Error	Located by condensing unit (white)
LO	Low Temperature Alarm	Reference "AL" & "Ad" alarm parameter
HI	High Temperature Alarm	Reference "AH" & "Ad" alarm parameter

Note: If there is a probe error, first check connection to electronic control. Then check resistance value. See troubleshooting section of manual.

PROBE RESISTANCE VALUES

Temp.			Resistance			Temp.			Resistance			Temp.			Resistance		
°F	°C	Typ KΩ	°F	°C	Typ KΩ	°F	°C	Typ KΩ	°F	°C	Typ KΩ	°F	°C	Typ KΩ	°F	°C	Typ KΩ
-15	-26	90.84	34	1	26.13	82	28	8.94									
-13	-25	86.43	36	2	25.03	84	29	8.62									
-11	-24	82.26	37	3	23.99	86	30	8.31									
-9	-23	78.33	39	4	23.00	88	31	8.01									
-8	-22	74.61	41	5	22.05	90	32	7.73									
-6	-21	71.10	43	6	21.15	91	33	7.45									
-4	-20	67.77	45	7	20.30	93	34	7.19									
-2	-19	64.57	46	8	19.48	95	35	6.94									
0	-18	61.54	48	9	18.70	97	36	6.70									
1	-17	58.68	50	10	17.96	99	37	6.47									
3	-16	55.97	52	11	17.24	100	38	6.28									
5	-15	53.41	54	12	16.56	102	39	6.03									
7	-14	50.98	55	13	15.90	104	40	5.83									
9	-13	48.68	57	14	15.28	106	41	5.63									
10	-12	46.50	59	15	14.69	108	42	5.44									
12	-11	44.43	61	16	14.12	109	43	5.26									
14	-10	42.47	63	17	13.58	111	44	5.08									
16	-9	40.57	64	18	13.06	113	45	4.91									
18	-8	38.77	66	19	12.56	115	46	4.75									
19	-7	37.06	68	20	12.09	117	47	4.59									
21	-6	35.44	70	21	11.63	118	48	4.44									
23	-5	33.90	72	22	11.20	120	49	4.30									
25	-4	32.44	73	23	10.78	122	50	4.16									
27	-3	31.05	75	24	10.38	124	51	4.03									
28	-2	29.73	77	25	10.00	126	52	3.90									
30	-1	28.48	79	26	9.63	157	53	3.77									
32	0	27.28	81	27	9.28	129	54	3.65									

HOW TO REMOVE THE ELECTRONIC CONTROL

1. Turn off power to the unit.



2. Place tip of small flat head screw driver under plastic bezel and gently pry up on bezel to remove.



3. Use a PZ1 screw driver (#1 Phillips will also work) and turn both screws ¼ turn counter clockwise. This will rotate the plastic keeper behind the sheet metal to be able to pull out the electronic control.



Plastic Keeper. When turning screw counter clockwise, this will rotate this keeper.



When the screw is turned ¼ turn CCW, the plastic keeper will be in a position to remove the control.



4. To re-install the control, push the control back into the rectangular cutout. Turn the (2) screws clockwise to rotate the keeper back in place and secure the control. Snap back on the plastic bezel.



SPLIT CONTROL PARAMETERS

1.215/216
REV. 5/21/2019

Par.	Description	Level	Unit										
				C8IA41 UPRIGHT FRZR, SWF	C8IA41>10D UPRIGHT FRZR -10F	C8IA41>15D UPRIGHT FRZR -15F	C8IA41>28D UPRIGHT FRZR 28F	C8IA41>CEL UPRIGHT FRZR CELSIUS	C8IA41>38D SW SOLID TOPS	C8IA41>38DOT SW OPEN TOPS	C8IA41>28DNH SW SOLID TOP 28F	C8IA41>EFC IFS, 1FSE, DL1FS, DL1FSE	C8IA41>CFA CFA MODELS
/2	measurement stability: lower quicker resp	PW	-	4	4	4	4	4	4	4	4	4	4
/3	probe display response: lower quicker resp	PW	-	1	1	1	1	1	1	1	1	1	1
/4	probe display select 1: box 2: evap 3: amb	PW	-	1	1	1	1	1	1	1	1	1	1
/5	units in °C (0) or °F (1)	PW	-	1	1	1	1	0	1	1	1	1	1
/6	decimal display (0) or not (1)	PW	-	1	1	1	1	0	1	1	1	1	1
/C1	probe 1 offset (display)	User	°F	2.5	2.5	2.5	1.2	1.4	1.2	0	1.2	2.5	10.0
/C2	probe 2 offset (evap)	PW	°F	1	1	1	1	0.6	1.2	0	1	1	1
/C3	probe 3 offset (ambient)	PW	°F	0	0	0	0	0	0	0	0	0	0
St	set point (cutout)	User	°F	-2	-10	-15	26	-18.9	36	36	26	-3	-2
rd	differential (positive dif)	PW	°F	5	5	5	4	2.8	4	3	4	6	5
r1	minimum set point allowed	PW	°F	-10	-18	-18	20	-23.3	32	32	20	-10	-10
r2	maximum set point allowed	PW	°F	15	15	15	40	-9.4	40	40	40	15	15
FH	FH enabled	PW	-	1	1	1	1	1	2	2	2	1	1
FHt	fascia heater threshold: temp heaters turn on	PW	°F	80	80	80	80	26.7	80	80	80	80	80
FHd	fascia heater differential	PW	°F	1	1	1	1	1	1	1	1	1	1
c0	comp and fan start delay power up	PW	min	1	1	1	1	1	1	1	1	1	1
c1	min time between starts	PW	min	2	2	2	2	2	3	3	2	2	2
c2	min comp off time	PW	min	1	1	1	1	1	1	1	1	1	1
c3	min comp on time	PW	min	1	1	1	1	1	2	2	1	1	1
c4	compressor on time with duty cycle	PW	min	14	15	15	8	14	6	6	8	14	14
d0	type of defrost	PW	-	0	0	0	0	0	0	0	0	0	0
dl	interval between defrosts	User	hr	6	8	8	8	8	6	6	8	8	8
dt	end defrost temperature	PW	°F	50	50	50	44	10	40	44	44	50	50
dP	max defrost duration	PW	min	30	30	30	20	30	40	40	20	30	30
d6	display during defrost (1: temp 2: DF)	PW	-	1	1	1	1	1	1	1	1	1	1
dd	dripping time	PW	min	3	3	3	3	3	0	0	3	3	3
d8	alarm bypass after defrost	PW	hr	2	2	2	2	2	2	2	2	2	2
d/	display defrost probe (displays def temp)	PW	°F	-	-	-	-	-	-	-	-	-	-
A0	alarm and fan differential	PW	°F	-10	-10	-10	-10	-5.6	-2	-2	-10	-10	-10
AL	low temp alarm	F	°F	-20	-20	-25	15	-28.9	30	30	15	-20	-20
AH	high temp alarm	F	°F	40	40	40	50	4.4	50	50	50	40	40
Ad	temp alarm delay	PW	min	60	60	60	60	60	60	60	60	60	60
A4	third input config (0: not used 13: amb probe)	PW	-	13	13	13	13	13	0	0	0	13	13

easy ELECTRONIC CONTROL FOR REFRIGERATORS, FREEZERS AND WARMERS

If control number not listed here, please consult factory. Celsius Temps in °C.

Par.	Description	Level	Unit	Set	Set	Set	Set	Set	Set	Set	Set	Set	Set	Set
F0	evap fan operation (0: on, 1: based on set pt. see F1)	PW	-	1	1	1	1	1	0	0	1	1	1	0
F1	evap fan control set point	PW	°F	30	30	30	42	-1.1	40	40	42	20	30	40
F2	stop evap fans if comp stops (0: per F0 1: off w/comp 2: cyclical see F4 & F5)	PW	-	2	2	2	2	2	2	0	2	1	2	2
F3	evap fan status during defrost (0: on 1: off)	PW	-	1	1	1	1	1	0	0	1	1	1	0
Fd	post-dripping time	PW	min	0	0	0	0	0	0	0	0	0	0	0
F4	fan duty on time (when F2=2)	PW	min	1	1	1	1	1	1	100	1	1	1	1
F5	fan duty off time (when F2=2)	PW	min	3	3	3	3	3	3	0	3	3	3	3
Pw	password	User	-	22	22	22	22	22	22	22	22	22	22	22
H0	serial address (if connecting to monitoring)	PW	-	1	1	1	1	1	1	1	1	1	1	1
H1	AUX output config (0: inactive 8: fac htr)	PW	-	8	8	8	8	8	0	0	0	8	8	0
H2	key enabled	PW	-	1	1	1	1	1	1	1	1	1	1	1
H4	disable buzzer	User	-	0	0	0	0	0	0	0	0	0	0	0
H5	detect changed parameters	PW	-	0	0	0	0	0	0	0	0	0	0	0
H7	management of 4th relay/serial comm	PW	-	1	1	1	1	1	1	1	1	1	1	1
H99	parameter level	PW	-	66	51	52	53	54	56	63	55	58	62	59
EZY	EZY sets (1: reset 2: Celsius 3: -15F 4: fan constant)	PW	-	0	0	0	0	0	0	0	0	0	0	0

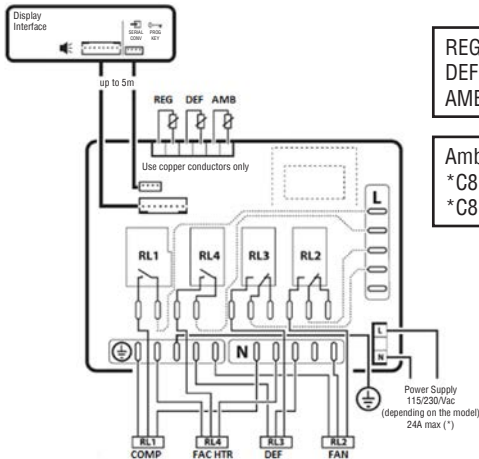

REGULATION PROBE: BLACK
DEFROST PROBE: RED
AMBIENT PROBE: WHITE

Ambient probe not installed on:
*C8IA41>38DNH
*C8IA41>38DOT

SELF-CONTAINED CONTROL PARAMETERS

2.015/016 PARAMETERS
Rev. 10/29/2019

Par.	Description	Level	Unit	Model									
				C0EA21K LINE 1 UPRIGHT REF	C0EA21K-NH CRA SOLID TOP, BBC, KC, CBC	C0EA21K-38D0T CRA OPEN TOP, CPA, GRIDDLE REF	C0EA21K-32DNH BBC DEEP CHILL	C0EA21K-55D LINE 1 UPRIGHT 55 DEG	C0EA21K-CEL LINE 1 UPRIGHT REF CELSIUS	C0EA21K-MCCW MILK COOLER COLD WALL	C0EA21K-MC MILK COOLER AIR		
Set	Set	Set	Set	Set	Set	Set	Set	Set	Set	Set	Set		
/2	measurement stability: lower quicker response	PW	-	4	5	4	4	4	4	4	2	4	
/4	probe display selection 1: box 2: evap 3: amb	PW	-	1	1	1	1	1	1	1	1	1	
/5	units in °C (0) or °F (1)	PW	-	1	1	1	1	1	0	1	1	1	
/6	decimal display (0) or not (1)	PW	-	1	1	1	1	1	0	1	1	1	
/C1	probe 1 offset (display)	User	°F	1.2	1.2	1.2	1.2	1.0	0.7	1.0	1.2	1.2	
/C2	probe 2 offset (evap)	PW	°F	1.2	1.2	1.2	1.2	1.0	0.7	0.0	1.2	1.2	
/C3	probe 3 offset (ambient)	PW	°F	0	0	0	0	0	0	0	0	0	
St	set point (cutout)	User	°F	36	36	36	25	51	2.2	38	35	35	
rd	differential (positive dif)	PW	°F	4	3	3	5.0	4	2.2	3	5	5	
r1	minimum set point allowed	PW	°F	32	32	33	20	34	0	32	33	33	
r2	maximum set point allowed	PW	°F	40	40	40	38	55	4.4	40	40	40	
FH	FH enabled	PW	-	1	2	2	2	1	1	2	2	2	
FHt	fascia heater threshold: 0 inactive	PW	°F	80	0	0	0	80	26.7	0	0	0	
FHd	fascia heater differential	PW	°F	1	1	1	1	1	1	1	1	1	
Pr	power	User	-	1	1	1	1	1	1	1	1	1	
c0	comp and fan start delay power up	PW	min	1	1	1	1	1	1	1	1	1	
c1	min time between starts	PW	min	3	2	2	3	3	3	3	2	2	
c2	min comp off time	PW	min	1	1	1	1	1	1	1	1	1	
c3	min comp on time	PW	min	2	1	1	2	2	2	2	1	1	
c4	compressor on time with duty cycle	PW	min	6	6	6	8	5	6	3	6	6	
d0	type of defrost: 1 time init., time or temp term.	PW	-	1	1	1	1	1	1	0	1	1	
dl	interval between defrosts	User	hr	6	6	6	8	6	6	0	6	6	
dt	end defrost temperature	PW	°F	44	44	45	50	44	6.7	37	45	45	
dP	max defrost duration	PW	min	40	40	40	30	40	40	60	40	40	
d6	display during defrost (1: temp 2: DF)	PW	-	1	1	1	1	1	1	0	1	1	
dd	dripping time	PW	min	0	0	0	3	0	0	0	0	0	
d8	alarm bypass after defrost	PW	hr	2	2	2	2	2	2	2	2	2	
d/	display defrost probe (displays def temp)	PW	°F	-	-	-	-	-	-	-	-	-	

If control number not listed here, please consult factory.
Celsius Temps in °C.

Par.	Description	Level	Unit	COEA21K LINE1 UPRIGHT REF	COEA21K>NH CRA SOLID TOP, BBC, KC, CBC	COEA21K>38DOT CRA OPEN TOP, CPA, GRIDDLE REF.	COEA21K>32DNH BBC DEEP CHILL	COEA21K>55D LINE 1 UPRIGHT 55 DEG	COEA21K>CEL LINE 1 UPRIGHT REF CELSIUS	COEA21K>MCCW MILK COOLER COLD WALL	COEA21K>MC MILK COOLER AIR
Set	Set	Set	Set	Set	Set	Set	Set	Set	Set	Set	Set
A0	alarm and fan temp differential	PW	°F	-2	-2	-2	-5	-2	-1.2	-2	-2
AL	low temp alarm	F	°F	30	30	25	18	30	-1.1	30	25
AH	high temp alarm	F	°F	50	50	50	50	65	10	50	50
Ad	temp alarm delay	PW	min	60	60	60	60	60	60	60	60
Fd0	fan duty on time	PW	min	1	1	100	100	1	1	0	100
FdF	fan duty off time	PW	min	3	3	0	0	3	3	3	0
Pw	password	User	-	22	22	22	22	22	22	22	22
H0	serial address (if connecting to monitoring)	PW	-	1	1	1	1	1	1	1	1
H2	key enabled	PW	-	1	1	1	1	1	1	1	1
H4	disable buzzer	User	-	0	0	0	0	0	0	0	0
H5	detect changed parameters	PW	-	0	0	0	0	0	0	0	0
H99	parameter level	PW	-	0	10	11	3	5	4	6	13
EZY	EZY sets (1: reset 2: Celsius 3: wine 4: fan constant	PW	-	0	0	0	0	0	0	0	0

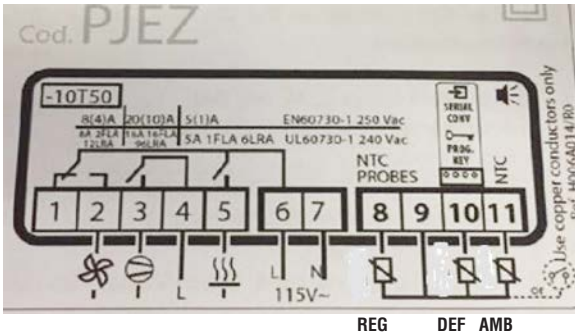

REGULATION PROBE: BLACK
DEFROST PROBE: RED
AMBIENT PROBE: WHITE

- COEA21K: RELAY 5 FOR FASCIA HEATERS
- COEA21K>NH: RELAY 5 NOT USED. AMBIENT (WHITE) PROBE NOT USED
- COEA21K>38DOT: RELAY 5 NOT USED. AMBIENT (WHITE) PROBE NOT USED
- COEA21K>32DNH: RELAY 5 FOR DEF HEATER. AMBIENT (WHITE) PROBE NOT USED
- COEA21K>CEL: RELAY 5 FOR FASCIA HEATERS
- COEA21K>MCCW: RELAY 5 NOT USED. RELAY 2 NOT USED. AMBIENT (WHITE) NOT USED. DEF (RED) NOT USED.
- COEA21K>MC: RELAY 5 NOT USED. AMBIENT (WHITE) NOT USED.

WARMER CONTROL PARAMETERS

If control number is not listed here, please consult factory.

S2L000>W (220V)
S2L100>W (115V)

Par.	Description	Level	Unit	Set
/2	Measurement Stability: Lower quicker response	PW	-	2
/5	Units in °C (0) or °F (1)	PW	-	1
/6	decimal display (0) or not (1)	PW	-	1
/C1	probe 1 offset (display)	User	°F	4.0
St	set point (cutout)	User	°F	182
rd	differential (negative dif)	PW	°F	2
r1	minimum set point allowed	PW	°F	90
r2	maximum set point allowed	PW	°F	195
c1	min time between starts	PW	min	0
c2	min heater off time	PW	min	0
c3	min heater on time	PW	min	0
c4	heater on time with duty cycle	PW	min	9
A0	alarm and fan temp differential	PW	°F	-2
AL	low temp alarm	F	°F	60
AH	high temp alarm	F	°F	220
Ad	temp alarm delay	PW	min	60
Pw	password	User	-	22
H0	serial address (if connecting to monitoring)	PW	-	1
H2	keypad enabled	PW	-	1
H4	disable buzzer	User	-	0
H5	detect changed parameters	PW	-	1
EZY	EZY Sets (1: Reset, 2: Celsius)	PW	-	0

WARMER

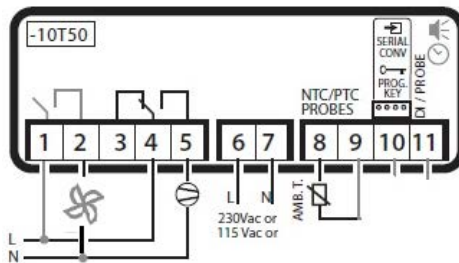

Continental[®]

Refrigerator

A Division of National Refrigeration & Air Conditioning Products, Inc.
539 Dunksferry Road • Bensalem, PA 19020-5908
Phone: 215-244-1400 • Toll Free: 800-523-7138
www.continentalrefrigerator.com