

WORKTOP REFRIGERATOR

Model: SW60NSGD

Natural Refrigerant R-290 Model

60" Display Worktop Refrigerator with Sliding Glass Doors

Stainless steel front, top and end panels, aluminum back and interior.



Options and Accessories

(upcharge and lead times may apply)

Stainless steel interior	Different caster sizes
Stainless steel back	Adjustable legs
Additional epoxy coated steel shelves	Door locks
Stainless steel shelves	Special electrical requirements (consult factory)
Overshelves (single or double)	

Consult factory for other model configurations, options and accessories.

Continental
Refrigerator



Project Name:

Model Specified:

Location:

Item No:

Quantity:

AIA #:

SIS #:

Standard Model Features

REFRIGERATION SYSTEM

Performance rated refrigeration system

Natural, environmentally safe, high efficiency R-290 refrigerant¹

Automatic, hot gas condensate evaporator

Non-corrosive, plasticized fin evaporator coil

Expansion valve system

Easily serviceable, back mounted compressor

CABINET ARCHITECTURE

2" non-CFC polyurethane foam insulation

Double pane, low emissivity, tempered, self closing sliding glass doors

Magnetic snap in door gaskets

Heavy duty, epoxy coated steel shelves

Completely enclosed, vented and removable case back

5" casters

MODEL FEATURES

Electronic control, off cycle defrost

LED interior lighting

¹ R-290 refrigerant meets all federal and state regulatory requirements.

APPROVAL:

Model Specifications

DIMENSIONAL DATA

Net Capacity (cubic feet)	17.0 (481 cu l)
Width, Overall (inches)	60 (1524 mm)
Depth, Overall (inches) (incl. top & bumpers)	31 (787 mm)
Height, Overall (inches) (incl. 5" casters)	35 1/4 (895 mm)
Shelf Area (square feet)	8.1 (0.8 sq m)
Number of Shelves	2
Number of Doors	2
Interior Depth (inches)	See Drawing
Interior Height (inches)	26 1/4 (667 mm)
Interior Width (inches)	56 (1422 mm)

REFRIGERANT DATA

Condensing Unit Size (H.P.)	1/4+
Capacity (BTU per hour)*	2073

ELECTRICAL DATA

Voltage (International)	115/60/1 (220/50/1)
Total Amps (International)	3.9 (1.8)
10 ft. Cord/Plug [attached] (International)	Yes (No)

SHIPPING DATA

Weight (pounds)	315 (143 kg)
Height - Crated (inches)	43 1/4 (1099 mm)
Width - Crated (inches)	68 (1727 mm)
Depth - Crated (inches)	37 1/4 (946 mm)

* Rating @ +25°F evaporator, 90°F ambient
Figures in parentheses reflect metric equivalents rounded to the nearest whole unit.



Equipped with one NEMA-5-15P Plug
(varies by country)

Model Plan Views

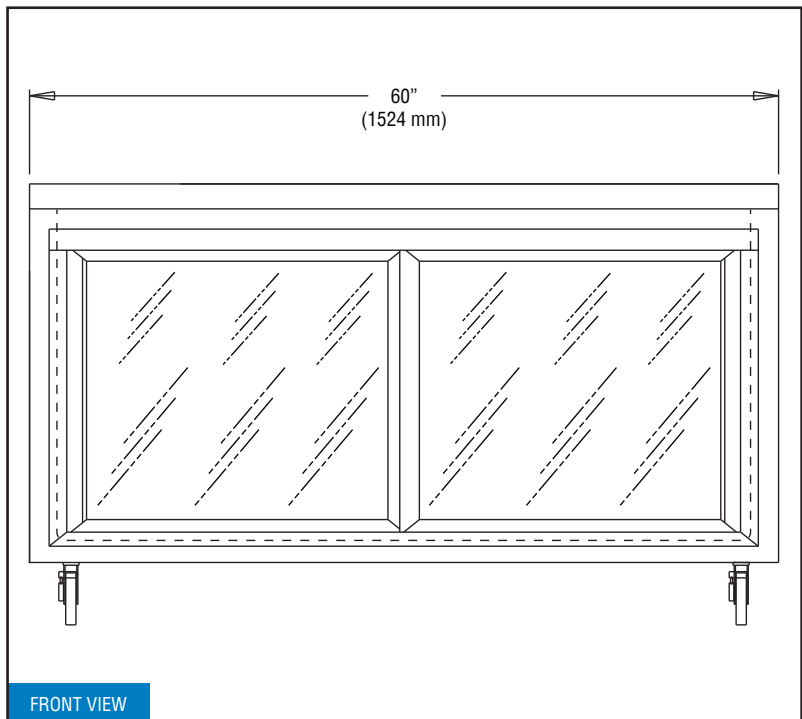

FRONT VIEW

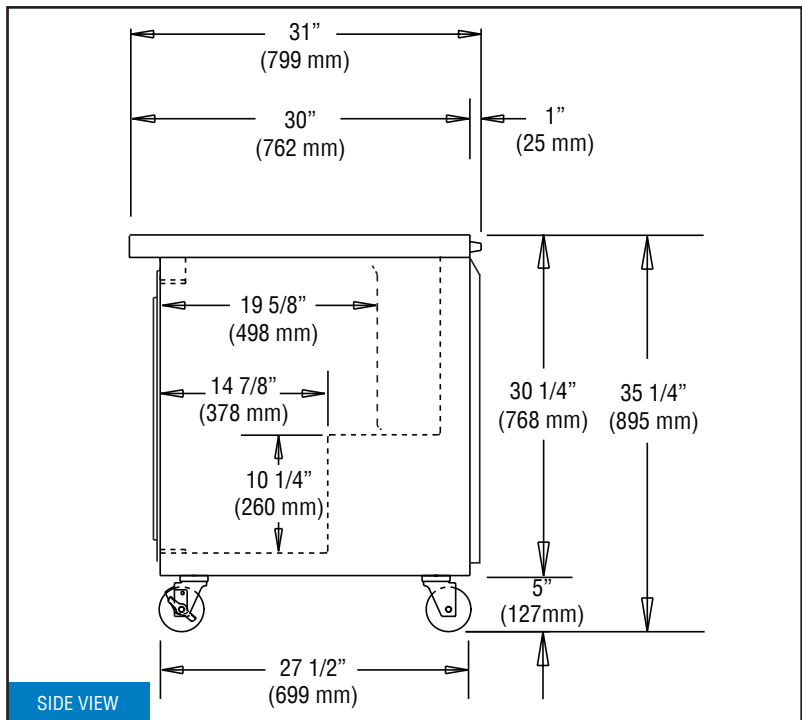

SIDE VIEW

IMPORTANT NOTE: If the cabinet is located directly against a wall, a minimum clearance of 3" is required on sides, front and rear.

Continental
Refrigerator

Toll-Free: 800-523-7138
Phone: 215-244-1400
Fax: 215-244-9579

539 Dunksferry Road
Bensalem, PA 19020
www.continentalrefrigerator.com

Due to our continued efforts in developing innovative products, specifications subject to change without notice.



PROUDLY
DESIGNED & ASSEMBLED
IN THE U.S.A.

Intertek

© Copyright 2021. Continental Refrigerator.
A Division of National Refrigeration & Air Conditioning Products, Inc.

REVISED: 4/2/24